

HALSTEAD

British Made Boilers

Flue Options



*Ace • Finest • Finest Gold
Best 30/40/50/60 • Best 80*

British Made Boilers

Halstead have been manufacturing boilers in the UK since 1975. From its present manufacturing base in Halstead, Essex, the Company now produces a wide range of boiler products distributed the length and breadth of Britain and Ireland.

Halstead Boilers are totally committed to the design and manufacture of high performance domestic central heating appliances and supports its product with a dedicated Technical Services and Training Centre in Leamington Spa, Warwickshire. A nationally appointed network of Service Agents ensures that after installation queries can be dealt with by a fully trained, locally based service engineer.

Halstead appliances and flueing accessories are available from independent merchants and regional merchant groups throughout Britain and Ireland.

Halstead Boilers are also fully committed to providing a spares service for both existing and discontinued appliances. A full range of Halstead boiler spares are available from our nationally appointed network of dedicated Spares stockists.



For full information on our products, spares and services visit our website at www.halsteadboilers.co.uk



Ace



Finest



Finest Gold



**Best
30/40/50/60**

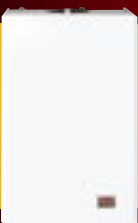

Best 80

FLUE OPTIONS



This Flue Application Guide is intended to complement the Installation and Service Instructions supplied with each Halstead appliance.

The guide provides the installer with full and detailed information on the various flueing options commonly used with our range of wall mounted appliances.

It also gives information on our range of flue accessories available from Halstead boiler stockists nationwide.

If in doubt, please do not hesitate to call our

Service Helpline: 01926 834834.

RULE ONE:

The Ace, Finest, Finest Gold, Best 30/40/50/60 and Best 80 each have their own maximum flue lengths both horizontally and vertically.

Refer to the relevant sections shown on the following pages to check the suitability of each flue system for your installation needs.

You may need to purchase flue accessories. Refer to the flue system components technical specifications shown in each section.

RULE TWO:

The maximum allowable flue length for each appliance is reduced when a flue bend is included (ie an extension elbow).

RULE THREE:

The standard flue must terminate horizontally as shown in the Installation Instructions. A slight fall away from the appliance will reduce the possibility of any ingress of rain water.

RULE FOUR:

If the flue is to terminate vertically the Vertical Flue Terminal must be used.

RULE FIVE:

The flue system must use either a flanged elbow or a flanged vertical turret socket at the exit of the appliance.

RULE SIX:

All flue joints must be secured in accordance with the Installation Instructions supplied with each appliance.

RULE SEVEN:

Twin pipe systems shown in Section 12 allow longer flue lengths to be achieved. However the standard concentric flue supplied with the appliance must be discarded.

TELESCOPIC
Supplied as standard with the appliance.

4

EXTENDED HORIZONTAL

6

RAISED HORIZONTAL

8

VERTICAL

10

TWIN PIPE SYSTEMS

12

ACCESSORIES

14

Telescopic

The Ace, Finest, Finest Gold and Best appliances are supplied complete with a 90° flanged elbow and telescopic flue duct. Designed to suit the vast majority of installations, the elbow can be fitted to the appliance to point in any direction (45° intervals) whilst the flue duct is telescopic from 545mm up to a maximum length of 820mm measured from the centre of the flue outlet.

Fibre seal and "O" ring are supplied to seal between the appliance and the flanged elbow. Wall seals are also included to provide a neat finish on both inner and outer walls.

When the standard telescopic kit is used with the Finest and Finest Gold combination appliances and when no other flue components are used, a flue restrictor, supplied with the appliance, must be inserted.

If any other flue components or extensions are used, this restrictor must be discarded.

With the Ace combination boiler in right hand or left hand horizontal flue applications, and where the standard telescopic flue is used, a Flue Air Guide - supplied with the appliance, must be inserted as detailed in Installation Instructions. In rear, extended horizontal and vertical flue applications, this should be discarded.

With Finest, Finest Gold and Best boilers only, the standard telescopic flue kit is also suitable for high rise SE-DUCT applications where the flue duct feeds to a common flueing chamber (SE-DUCT) in the centre of the building.

Entry of the telescopic flue should be as close to the centre of the SE-DUCT as possible. The flue must not be positioned in the corner of the SE-DUCT.

The external wall sealing ring is not used and the end of the air duct must be fitted flush with the inside of the SE-DUCT chamber.

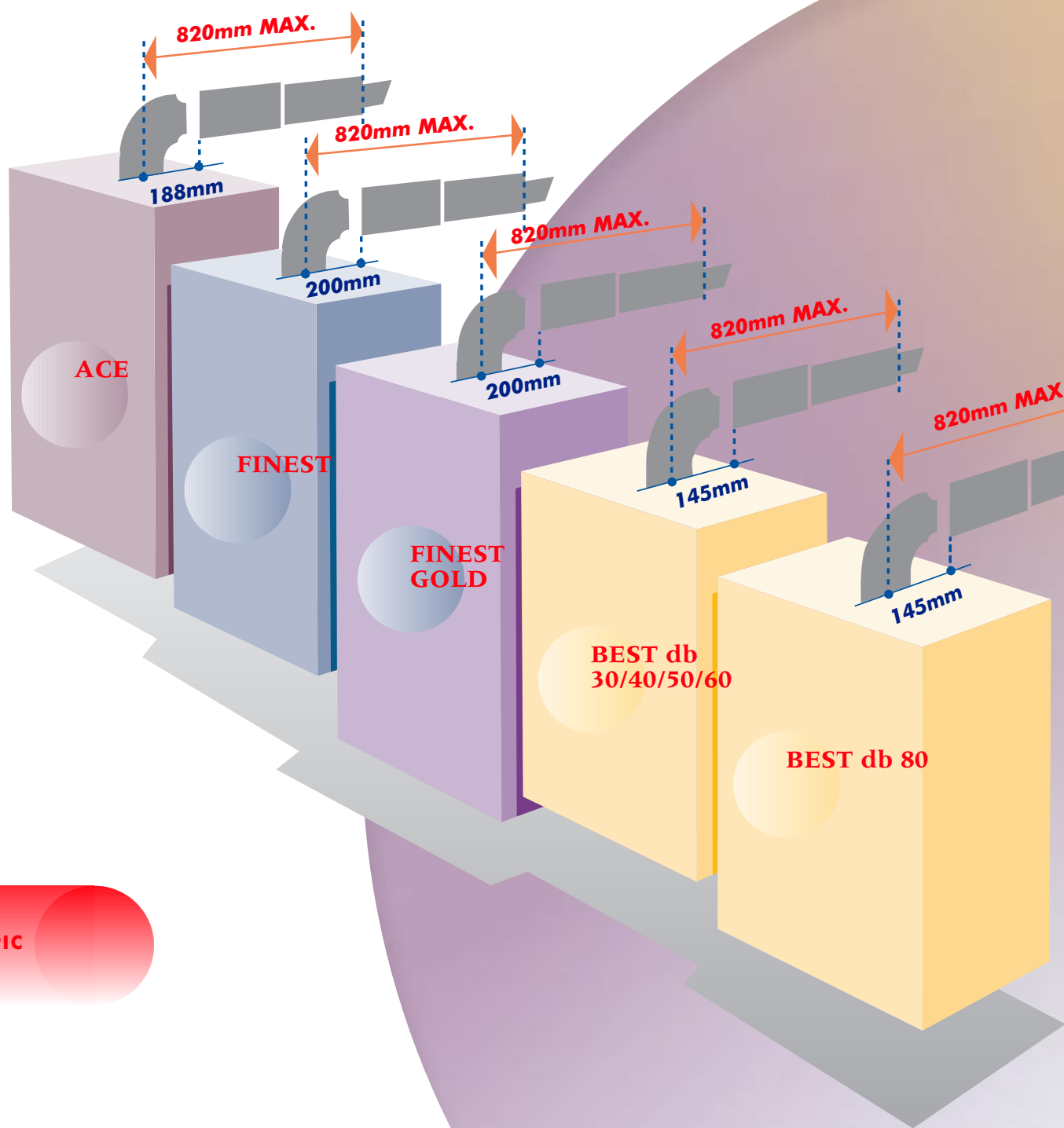

SE-DUCT APPLICATION

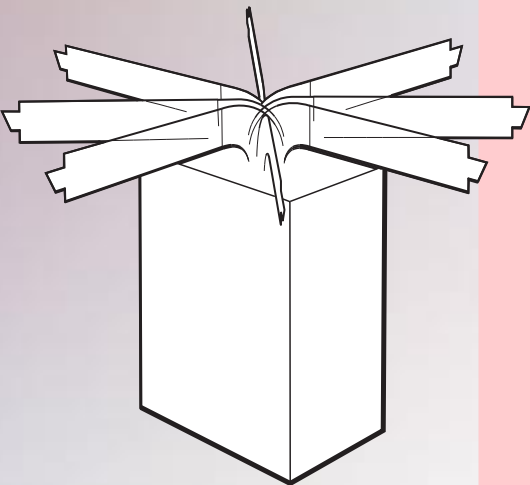
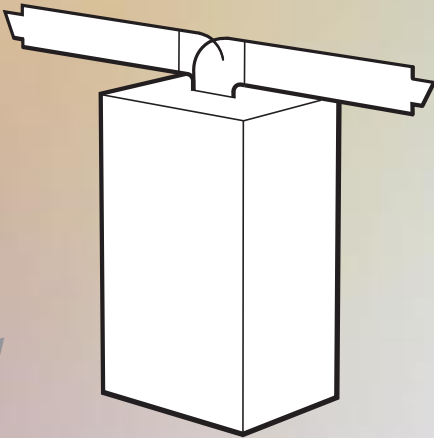
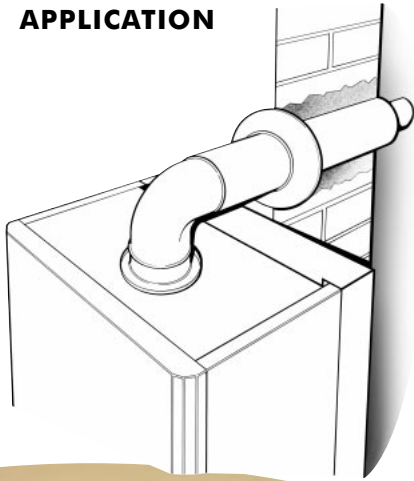

TELESCOPIC FLUE SYSTEM COMPONENTS



FINEST & FINEST GOLD FLUE RESTRICTOR

Part No: 251023
Supplied with the appliance.

This flue restrictor is designed specifically for the Telescopic Flue. And must only be used when no additional components are fitted.



ACE FLUE AIR GUIDE

Part No: 190059
Supplied with the appliance - to be used in RH/LH telescopic flue applications only.

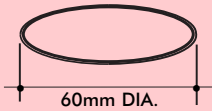

"O" RING SEAL

Supplied with the appliance.

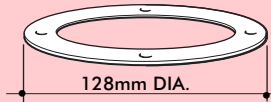
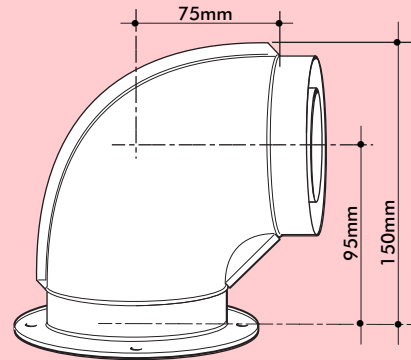

FIBRE SEAL

Part No: 352559
Supplied with the appliance.

90° FLANGED ELBOW

Part No: 130596
Supplied with the appliance.
Seal required.
Resistive length: 767mm

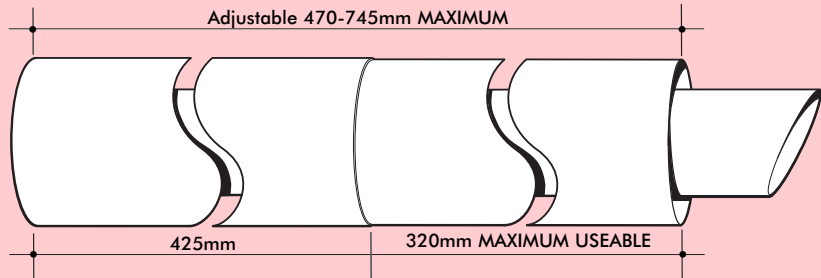

TELESCOPIC FLUE ASSEMBLY

Part No: 130605
Supplied with the appliance.

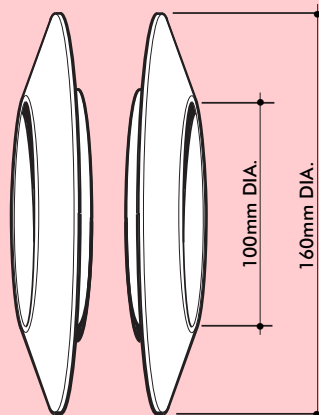

INTERNAL & EXTERNAL WALL SEALS

Part No: 352552 (White Inner)
Part No: 352016 (Grey Outer)
Supplied with the appliance.

Extended Horizontal

If the appliance cannot be sited close to an adjacent outside wall, it is possible to extend the telescopic flue with extension ducts and 90° or 45° elbows. Maximum allowable flue length varies between appliances and must be followed to ensure safe and correct appliance operation as illustrated below. In calculating the flue length the following must be considered:

- Each duct extension measures 817mm with a 767mm useable length (i.e. 50mm seal)
- A 90° extension elbow has an equivalent length of 767mm - this is known as the resistive length
- A 45° extension elbow has a resistive length of 375mm

In extending the flue ducting it is also possible to raise or lower the horizontal ducting. Ducting should not be lowered more than 500mm.

Fibre seal and "O" ring are supplied to seal between the appliance and the flanged elbow. Wall seals are also included to provide a neat finish on both inner and outer walls.

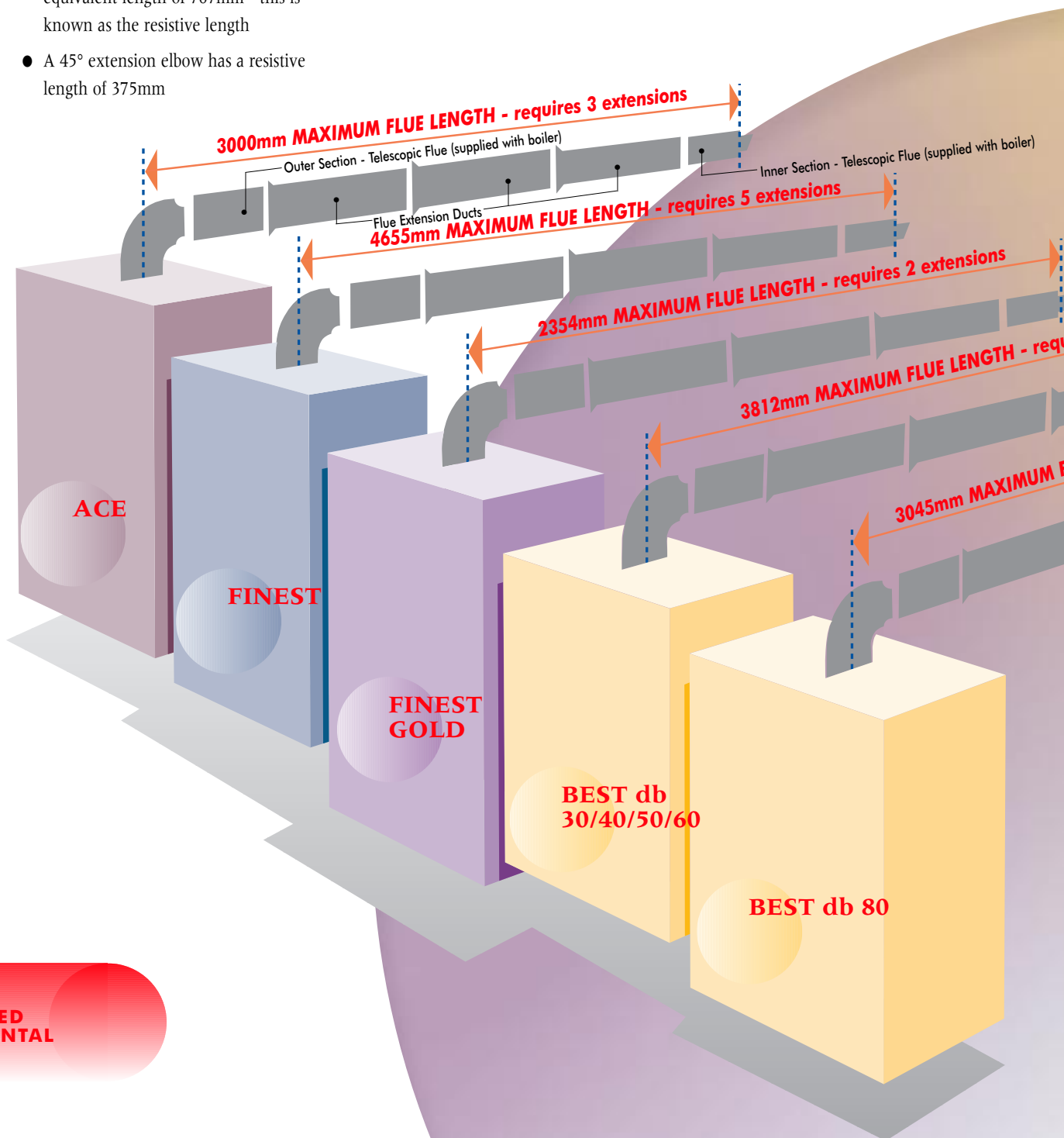

EXTENDED HORIZONTAL FLUE SYSTEM COMPONENTS

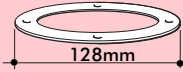

FIBRE SEAL
Part No: 352559
Supplied with the appliance.



"O" RING SEAL
Supplied with the appliance.

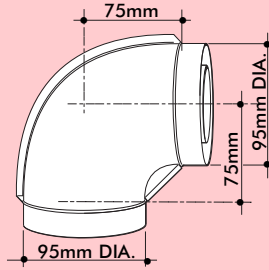

90° EXTENSION ELBOW
Part No: 954011
No Seal required.
Resistive length: 767mm

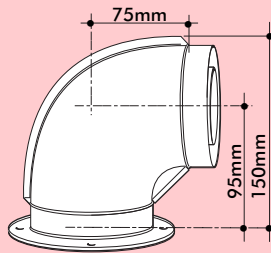

90° FLANGED ELBOW
Part No: 130596
Supplied with the appliance.
Seal required.

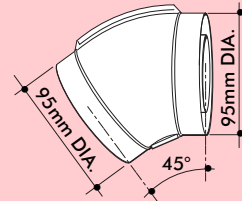

45° EXTENSION ELBOW
Part No: 954010
No Seal required.
Resistive length: 375mm

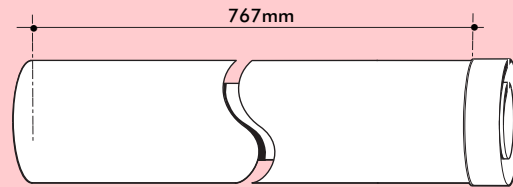

FLUE EXTENSION DUCT

Part No: 955065. Useable length: 767mm

*PLEASE NOTE: When using a Flue Extension Duct with an Extension Elbow, the 'flared' flange will need to be removed using a hacksaw on both inner and outer ducts.

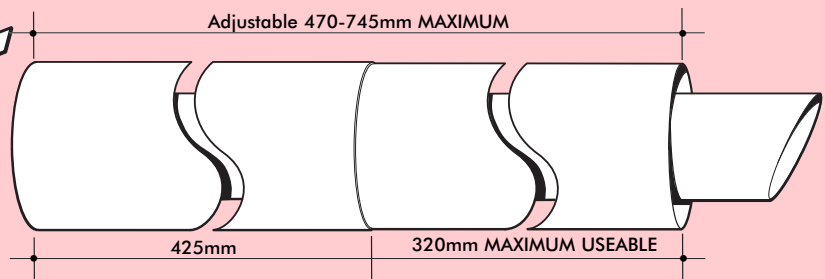
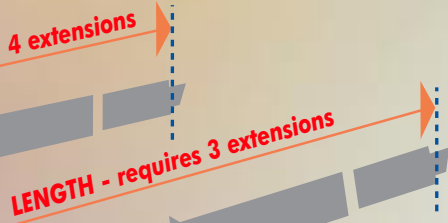

TELESCOPIC FLUE ASSEMBLY

Part No: 130605
Supplied with the appliance.

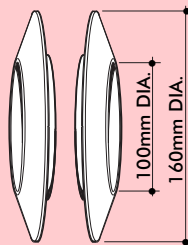

INTERNAL & EXTERNAL WALL SEALS

Part No: 352552 (White Inner)
Part No: 352016 (Grey Outer)
Supplied with the appliance.

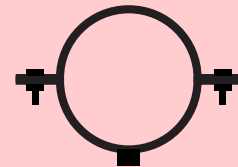

FLUE DUCT SUPPORT BRACKET

Part No: 840517
100mm dia, white

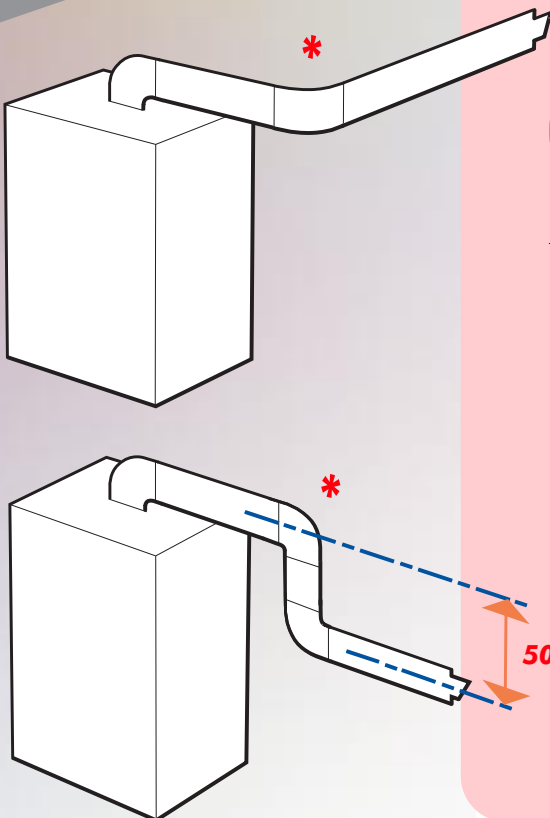

500mm MAX.

Raised Horizontal

If the desired outlet point is higher than the appliance, it is possible to raise the flue directly from the appliance and then to use the telescopic flue duct. If necessary this may be further extended horizontally with extension ducts, 90° or 45° elbows. In this application the 90° flanged elbow supplied with the appliance should be discarded and a vertical turret socket used to connect to the appliance.

Maximum raised horizontal flue lengths vary between appliance types and must be followed to ensure safe and correct appliance operation as illustrated below.

In calculating the flue length the following must be considered:

- Each duct has a useable length of 767mm
- A 90° extension elbow has a resistive length of 767mm

- A 45° extension elbow has a resistive length of 375mm
- In extending the flue ducting it is also possible to raise or lower the horizontal ducting. Ducting should not be lowered more than 500mm.
- Fibre seal and "O" ring are supplied to seal between the appliance and the flanged elbow. Wall seals are also included to provide a neat finish on both inner and outer walls.

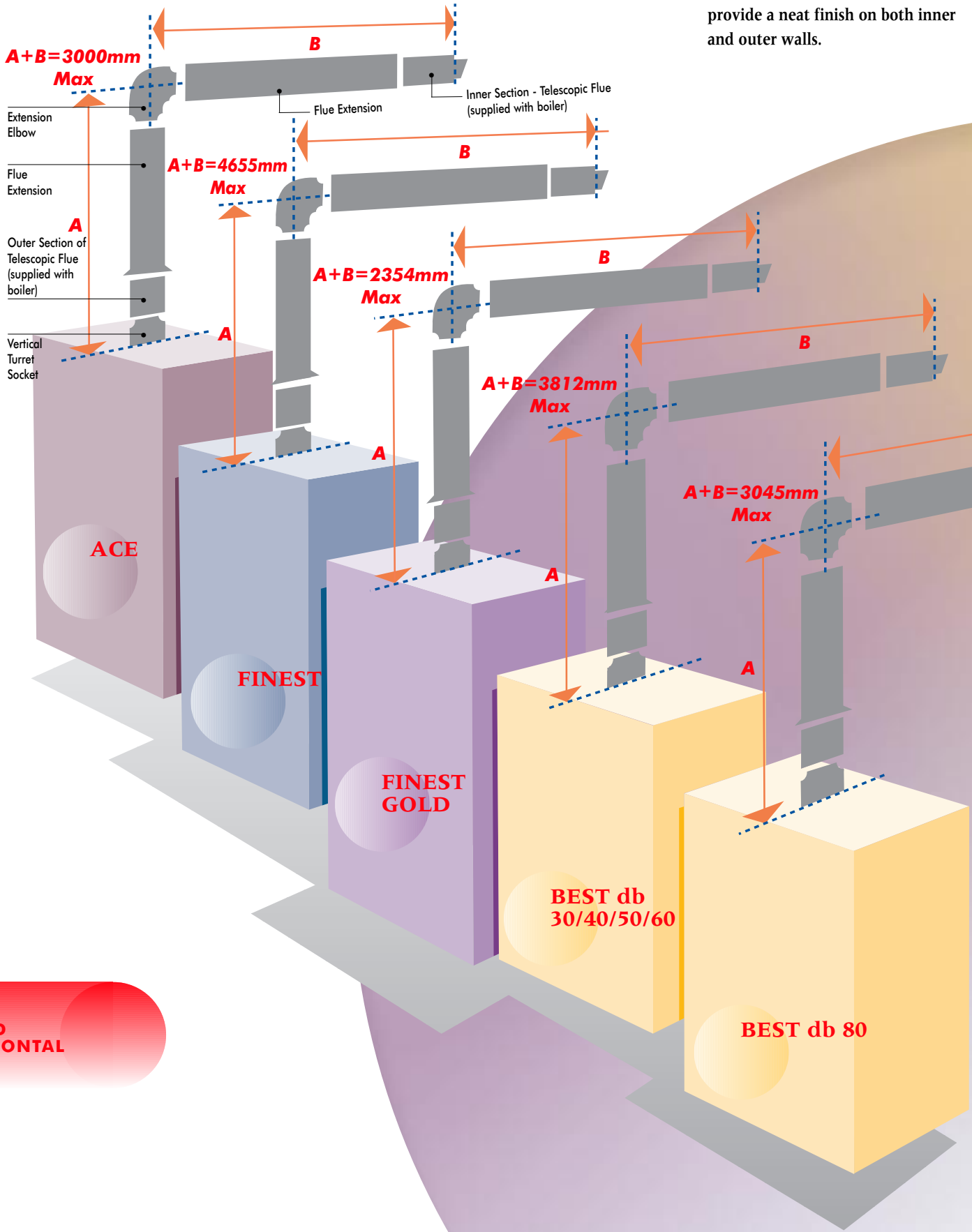

RAISED HORIZONTAL FLUE SYSTEM COMPONENTS

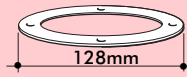
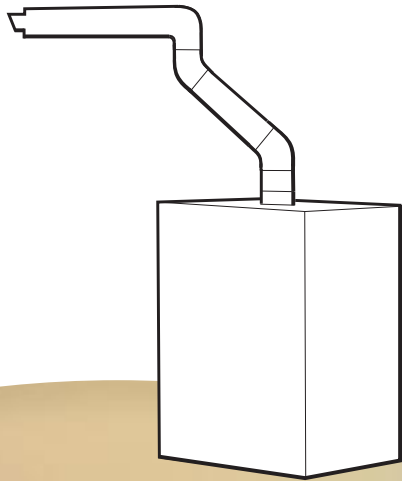

FIBRE SEAL
Part No: 352559
Supplied with the appliance.

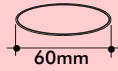

"O" RING SEAL
Supplied with the appliance.

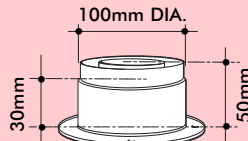

VERTICAL FLUE TURRET SOCKET
Part No: 130606
Supplied as part of Vertical Flue Kit.
Useable length 30mm

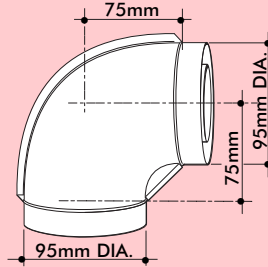

90° EXTENSION ELBOW
Part No: 954011
No Seal required.
Resistive length: 767mm

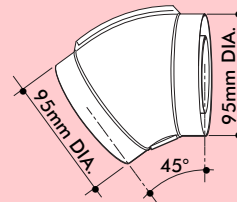

45° EXTENSION ELBOW
Part No: 954010
No Seal required.
Resistive length: 375mm

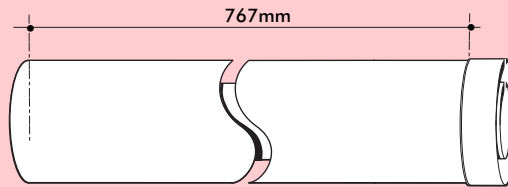

FLUE EXTENSION DUCT

Part No: 955065. Useable length: 767mm

*PLEASE NOTE: When using a Flue Extension Duct with an Extension Elbow, the 'flared' flange will need to be removed using a hacksaw on both inner and outer ducts.

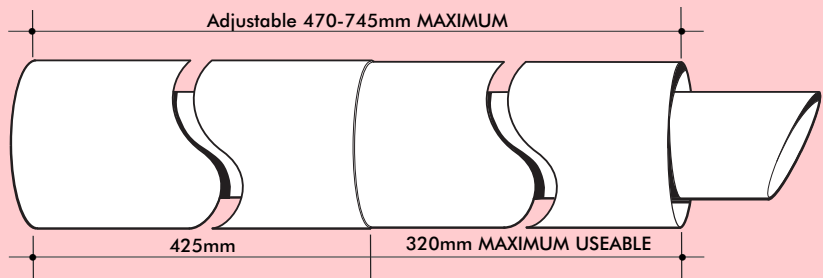
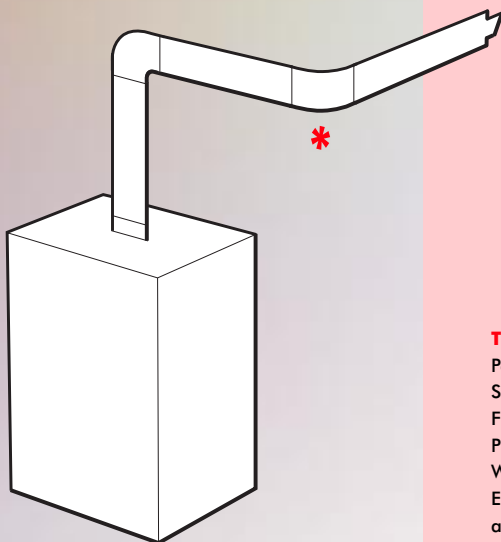

TELESCOPIC FLUE ASSEMBLY

Part No: 130605
Supplied with the appliance.
Flue Options Book

PLEASE NOTE

When using a Flue Extension Duct with an Extension Elbow, the 'flared' flange will need to be removed using a hacksaw on both inner and outer ducts.

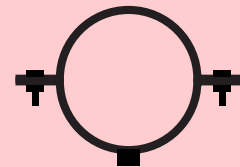

FLUE DUCT SUPPORT BRACKET

Part No: 840517
100mm dia, white

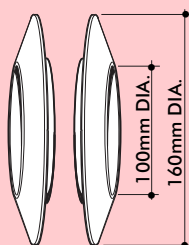

INTERNAL & EXTERNAL WALL SEALS

Part No: 352552 (White Inner)
Part No: 352016 (Grey Outer)
Supplied with the appliance.

Vertical

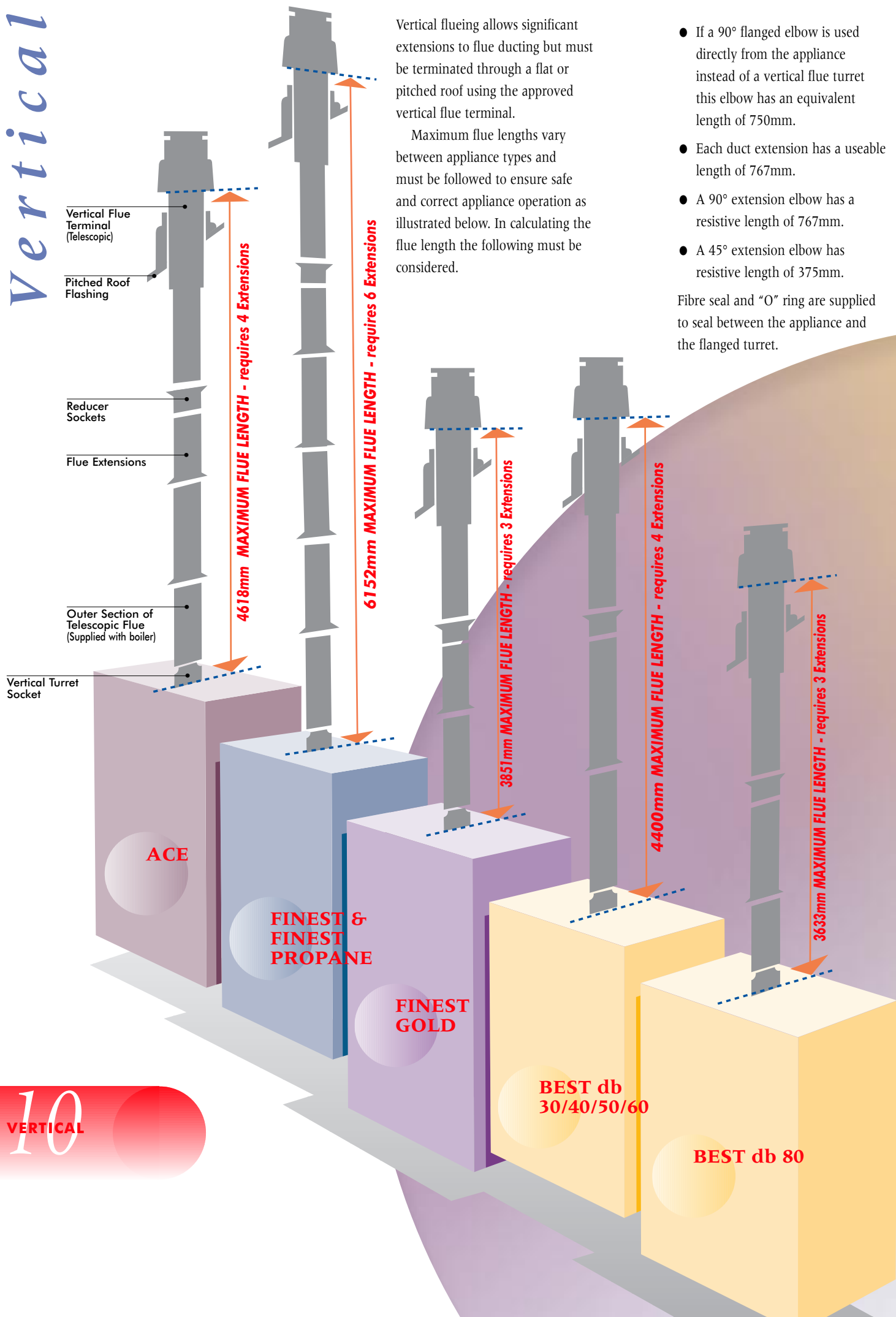

Vertical flueing allows significant extensions to flue ducting but must be terminated through a flat or pitched roof using the approved vertical flue terminal.

Maximum flue lengths vary between appliance types and must be followed to ensure safe and correct appliance operation as illustrated below. In calculating the flue length the following must be considered.

- If a 90° flanged elbow is used directly from the appliance instead of a vertical flue turret this elbow has an equivalent length of 750mm.
- Each duct extension has a useable length of 767mm.
- A 90° extension elbow has a resistive length of 767mm.
- A 45° extension elbow has resistive length of 375mm.

Fibre seal and "O" ring are supplied to seal between the appliance and the flanged turret.

NOTE

When a vertical flue is installed, the outer section of the standard telescopic flue (supplied with the appliance) must be used in conjunction with a Vertical Turret Socket, directly from the boiler. The inner telescopic section should be discarded. The Vertical Flue Roof Terminal then fits onto this section using a Reducer Socket. Extension Ducts may be inserted between.

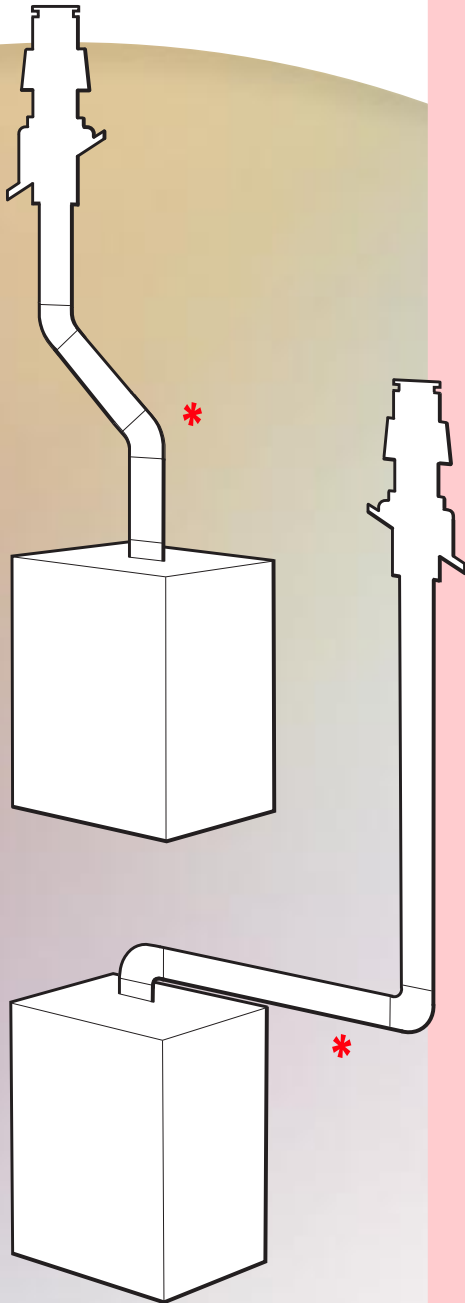

VERTICAL FLUE SYSTEM COMPONENTS

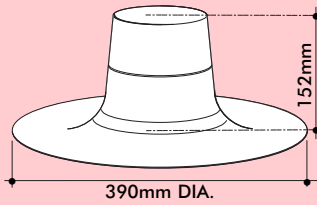

FLAT ROOF FLASHING
Part No: 840512

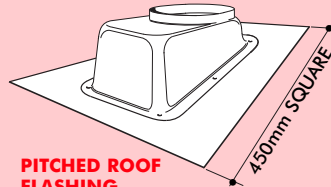

PITCHED ROOF FLASHING
Supplied as part of the Vertical Flue Kit.

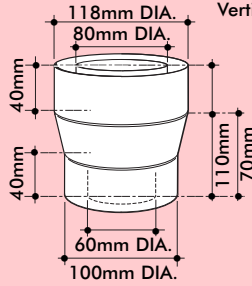

REDUCER SOCKETS
Supplied as part of the Vertical Flue Kit.
Useable length 70mm

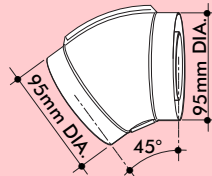

45° EXTENSION ELBOW
Part No: 954010
No Seal required.
Resistive length: 375mm

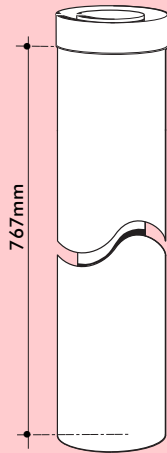

FLUE EXTENSION DUCT
Part No: 955065
Useable length: 767mm
Flue Options Book

***PLEASE NOTE**
When using a Flue Extension Duct with an Extension Elbow, the 'flared' flange will need to be removed using a hacksaw on both inner and outer ducts.

90° FLANGED ELBOW
Part No: 130596
Supplied with the appliance.
Seal required.
Resistive length: 750mm

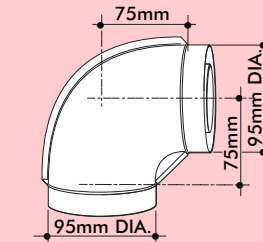

90° EXTENSION ELBOW
Part No: 954011
No Seal required.
Resistive length: 767mm

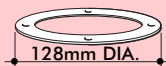
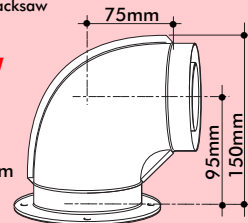

FIBRE SEAL
Part No: 352559
Supplied with the appliance.



"O" RING SEAL
Supplied with the appliance

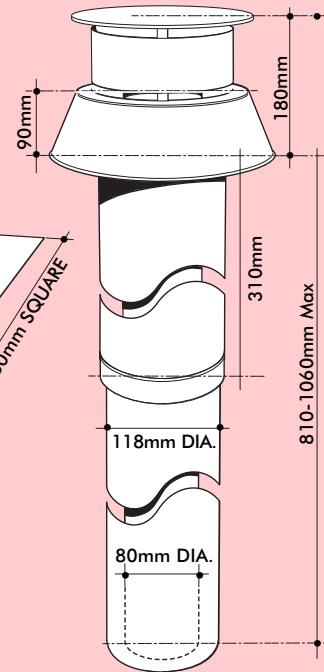

VERTICAL FLUE ROOF TERMINAL (with Telescopic Outer)
Part No: 840506
Note: Inner duct may require cutting

VERTICAL FLUE KIT: Part No: 988378
Comprising Part No's
840506 Vertical Flue Terminal.
Pitched Roof Flashing.
Reducer Sockets.
130606 Vertical Flue Turret Socket.

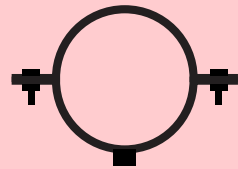

FLUE DUCT SUPPORT BRACKET
Part No: 840517
100mm dia, white

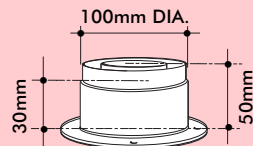

VERTICAL FLUE TURRET SOCKET
Part No: 130606
Supplied as part of Vertical Flue Kit.
Useable length 30mm

Twin-Pipe Systems

In special applications where very long runs of flue ducting are desired, it is possible to use a twin-pipe system. The Best and Finest appliance ranges may use a twin-pipe system in either horizontal or vertical form but on certain output models only.

The Ace and Finest Gold combination boilers are not tested for use with a twin-pipe system.

Maximum flue lengths vary between appliance types and must be followed to ensure safe and correct operation as illustrated below. In calculating the flue length the following must be considered.

- If a 90° elbow is used either directly from the appliance or in-line, this has an equivalent length of 1500mm.
- A 45° extension elbow has an equivalent length of 800mm.
- Each standard duct extension measures 1000mm with a 950mm useable length (i.e. 50mm seal).

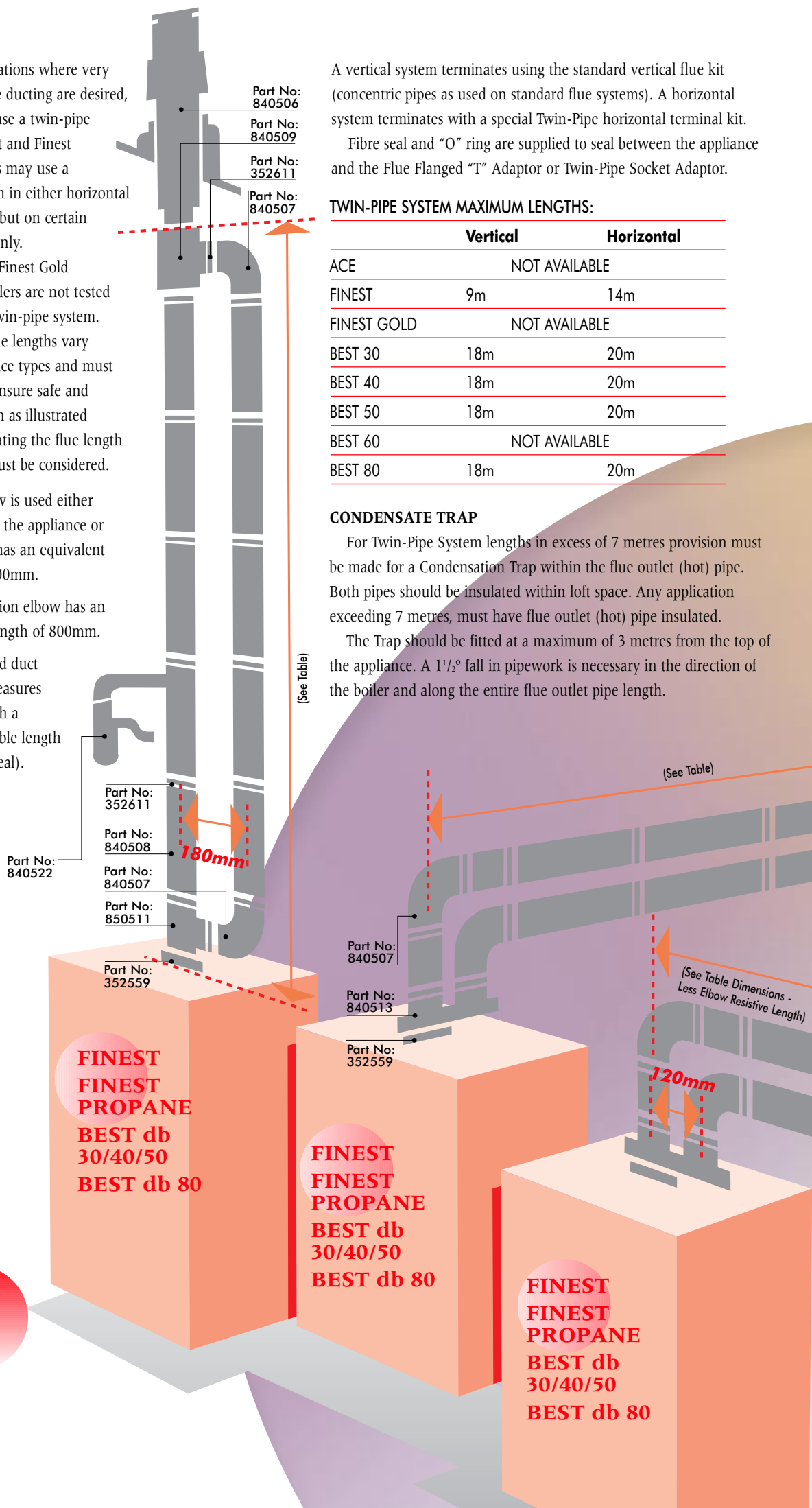

A vertical system terminates using the standard vertical flue kit (concentric pipes as used on standard flue systems). A horizontal system terminates with a special Twin-Pipe horizontal terminal kit.

Fibre seal and "O" ring are supplied to seal between the appliance and the Flue Flanged "T" Adaptor or Twin-Pipe Socket Adaptor.

TWIN-PIPE SYSTEM MAXIMUM LENGTHS:

	Vertical	Horizontal
ACE	NOT AVAILABLE	
FINEST	9m	14m
FINEST GOLD	NOT AVAILABLE	
BEST 30	18m	20m
BEST 40	18m	20m
BEST 50	18m	20m
BEST 60	NOT AVAILABLE	
BEST 80	18m	20m

CONDENSATE TRAP

For Twin-Pipe System lengths in excess of 7 metres provision must be made for a Condensation Trap within the flue outlet (hot) pipe. Both pipes should be insulated within loft space. Any application exceeding 7 metres, must have flue outlet (hot) pipe insulated.

The Trap should be fitted at a maximum of 3 metres from the top of the appliance. A 1½° fall in pipework is necessary in the direction of the boiler and along the entire flue outlet pipe length.

TWIN-PIPE FLUE SYSTEM COMPONENTS

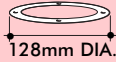

FIBRE SEAL
Part No: 352559
To seal flue adaptors to top of appliance.
Supplied with the appliance.

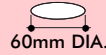

TWIN PIPE "O" RING SEAL
Part No: 352576
Supplied with the appliance.

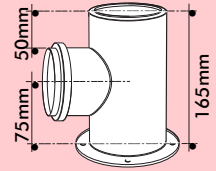

FLANGED "T" ADAPTOR FOR VERTICAL FLUEING
Part No: 840511

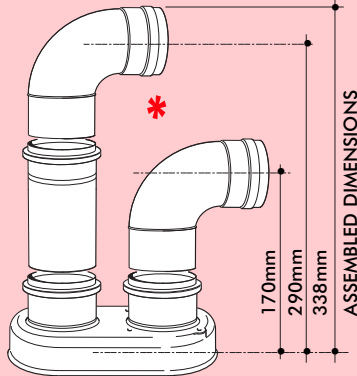

TWIN PIPE SOCKET ADAPTOR FOR HORIZONTAL FLUEING
Part No: 840513 for Finest/Finest Gold
Part No: 750875 for Best
(includes rubber mounting gasket)
*Elbows not supplied with kit

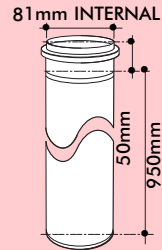

STANDARD EXTENSION DUCT
Part No: 840508
Resistive length: 950mm
For every length of extension a clamping bracket is recommended.



TWIN PIPE FLUE SEAL-80mm DIA.
Part No: 352611
Supplied with Elbows and Extensions.

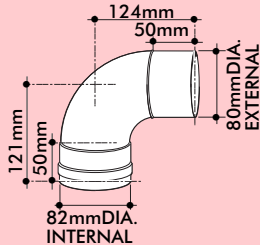

TWIN PIPE M&F 90° SWEEP ELBOW
Part No: 840507
Resistive length: 1500mm

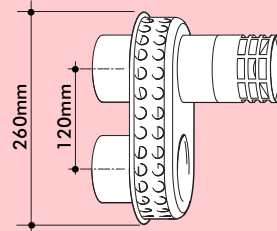

TWIN PIPE HORIZONTAL TERMINAL KIT
Part No: 840514

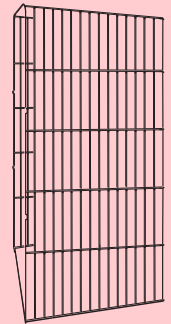

TWIN PIPE HORIZONTAL TERMINAL GUARD
Part No: 840515

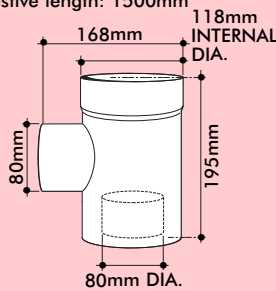

TWIN PIPE "T" ADAPTOR FOR VERTICAL FLUEING
Part No: 840509

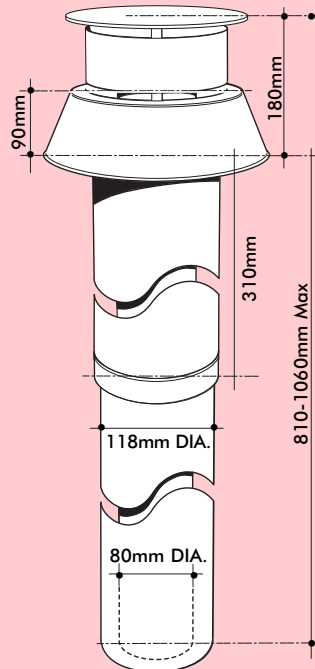

VERTICAL FLUE ROOF TERMINAL (WITH TELESCOPIC OUTER)
Part No: 840506
Note: Inner Duct may require cutting

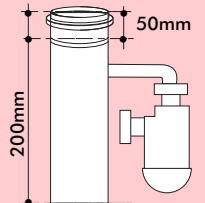

CONDENSATE KIT
Part No: 840522
Supplied with rubber hose condensate trap and collecting duct.

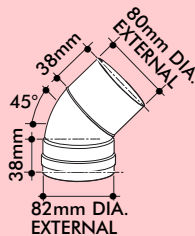

TWIN PIPE M&F 45° ELBOW
Part No: 840510
Resistive length: 800mm

VERTICAL FLUE KIT:
Part No: 988378
Comprising of Part No's
840506 Vertical Flue Terminal.
Pitched Roof Flashing.
130606 Vertical Flue TurretSocket. (Must be discarded)
Reducer Sockets. (Must be discarded)

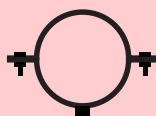

FLUE DUCT SUPPORT BRACKET
Part No: 840516
80mm dia, white

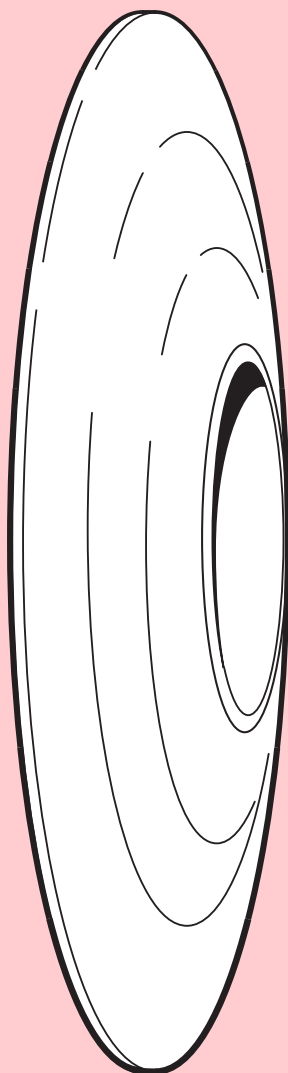

LARGE FLUE SEAL
Extra large wall sealing ring, (grey rubber), 300mm diameter. Used with standard flue terminals to seal enlarged holes.

Part No: 352020

COMBI CUP
Flow measuring cup suitable for use with combi-type appliances and instantaneous water heaters. Enables domestic hot water flow rates to be set or checked quickly and simply with an acceptable level of accuracy.

Part No: 954001

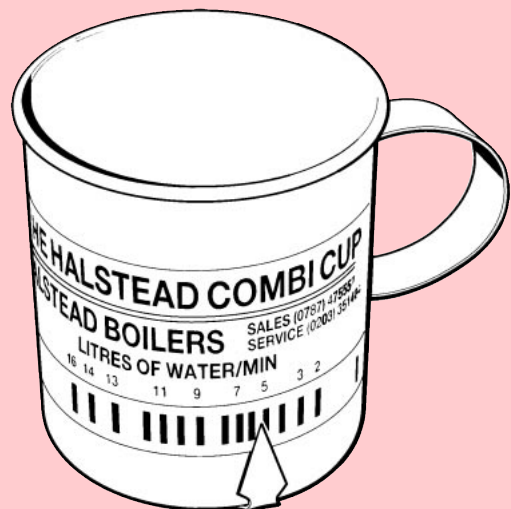

SERVICE MATE
Appliance service kit containing a range of fibre washers, "O" rings, screws, metal washers, spire clips, blind rivets, and cock washers.

Part No: 951528



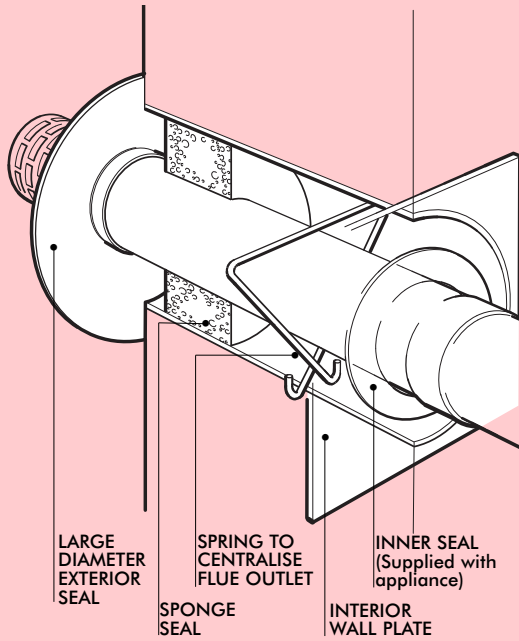

10/16 CONVERSION KIT

This kit is designed for installations where the flue opening left in the wall after removal of the old appliance is too large to be effectively sealed by the standard flue kit supplied with the new Halstead appliance.

It can be installed without access from outside and is therefore ideally suited for high rise applications.

Part No: 955062

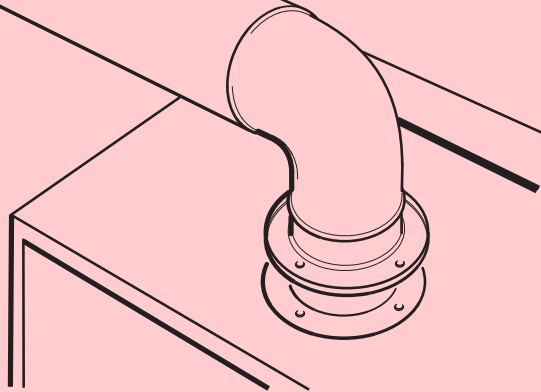

FINEST/FINEST GOLD "MBC" FIXING JIG

The Multifunctional Boiler Chassis is normally supplied complete with the Finest & Finest Gold, but is also available separately. It serves both as a wall template to mark the position of fixing holes and a mounting bracket to support Finest & Finest Gold appliances. It provides all water service connections so that the system pipework can be completed and commissioned prior to fitting the appliance. An essential feature where site security cannot be guaranteed during initial installation.

Part No: 988362

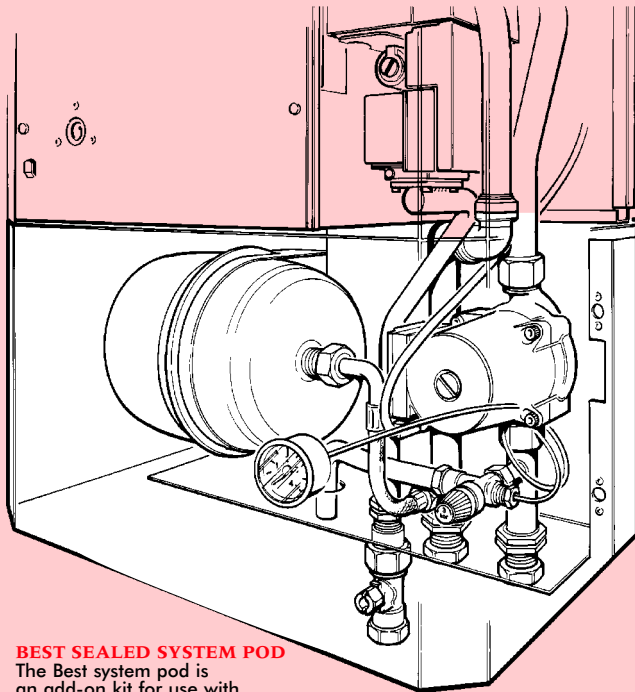
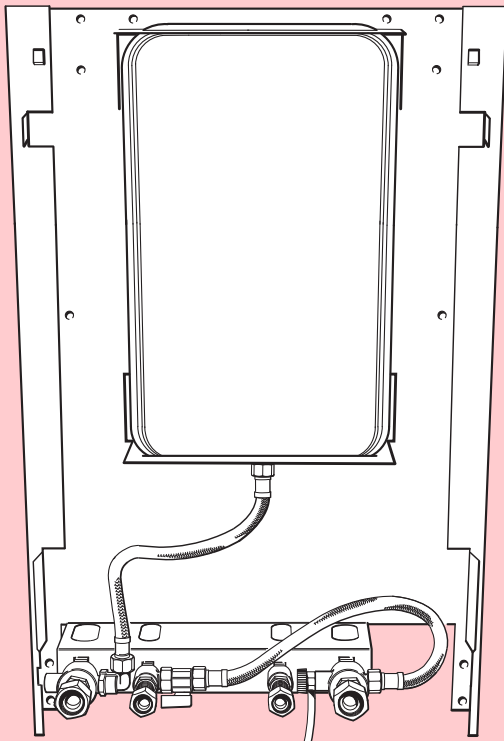

BEST SEALED SYSTEM POD

The Best system pod is an add-on kit for use with the Best30/40/50/60 & 80 appliances only. It enables the Best to be used with pressurised unvented systems and is designed to fit directly below the appliance itself.

The Pod is supplied with all pipework and wiring to connect the units together.

Part No: 955052 (Best 30/40/50/60)

Part No: 955061 (Best 80)



*Britain's Leading Independent
Boiler Manufacturer*

Halstead Boilers Limited, 20/22 First Avenue, Bluebridge Industrial Estate, Halstead, Essex CO9 2EX.
Tel: 01787 272800. Sales Direct Line: 01787 475557. Fax: 01787 474588. Service Helpline: 01926 834834.
e-mail: sales@halsteadboilers.co.uk or service@halsteadboilers.co.uk Website: www.halsteadboilers.co.uk

Flue Options • Flue Options • Flue Options • Flue Options

Halstead Boilers are continuously improving its products and may therefore change specifications without prior notice.
The statutory rights of the consumer are not affected.